



ACRYLIC PANEL CONCEPT



ACRYLIC PANEL c/w BRACKET



CROSS BAR c/w WIRE TRUNKING

ACRYLIC PANEL CONCEPT

SIMPLISM STYLE MEANS THE CONCISE. BOTH PRACTICAL AND COMFORTABLE, BEAUTIFUL AND HARMONIOUS APPEARANCE AND FUNCTION ON THE CONDITIONS.

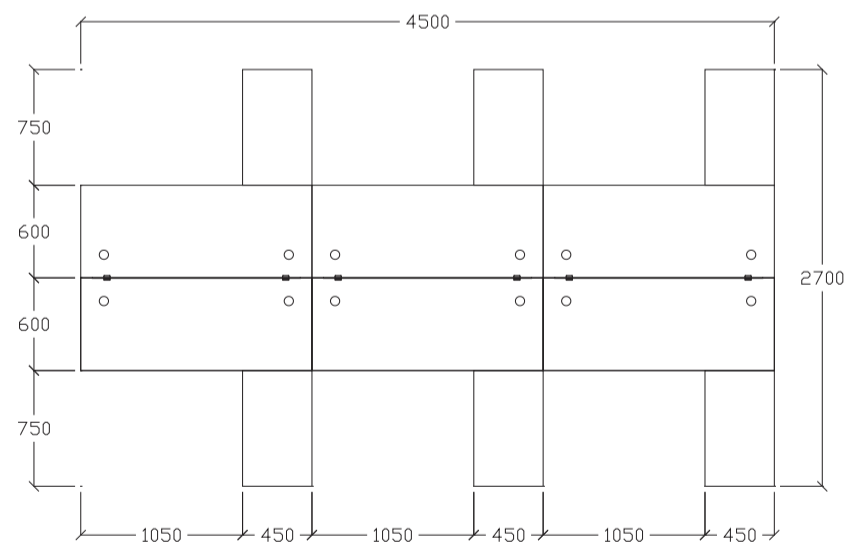



FABRIC COLOUR
53-BL

FRAMELESS CONCEPT

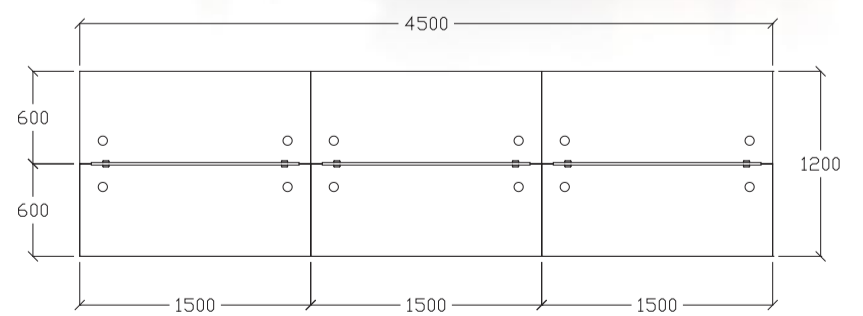

FRAMELESS PANEL c/w
BRACKET



CROSS BAR c/w WIRE
TRUNKING

FRAMELESS CONCEPT

ELEGANT AND GRACEFUL SHAPE, TENDER AND DELICATE FELL MAKE ALL SO COMFORTABLE AND NATURAL. DEMONSTRATE CLASSICAL FASHION AMONG YOUR ELEGANCE.



FABRIC COLOUR
20-OR

FRAMELESS CONCEPT

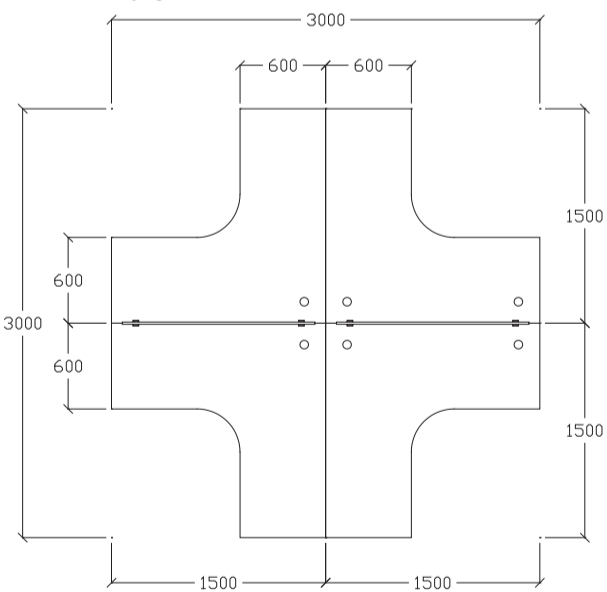

FRAMELESS PANEL c/w
BRACKET



CROSS BAR c/w WIRE
TRUNKING



FRAMELESS CONCEPT

SIMPLE AND SMOOTH LINES, INNOVATIVE STRUCTURES, FREE AND LIVELY APPEARANCE, COMBINED WITH THE NATURAL COLOR, TO CREATE EQUALITY, FREEDOM, CREATIVE WORK ENVIRONMENT.



FABRIC COLOUR
27-OR

AZOLLA CONCEPT

END POLE FINISHING
OPTION A



OPTION B



WIRE HOLDER



AZOLLA CONCEPT

GIVING MORE PLANNING FLEXIBILITY AND MAKING VERTICAL SPACE MORE EFFICIENT. FOR TEAMS THAT NEED TO WORK TOGETHER CLOSELY.

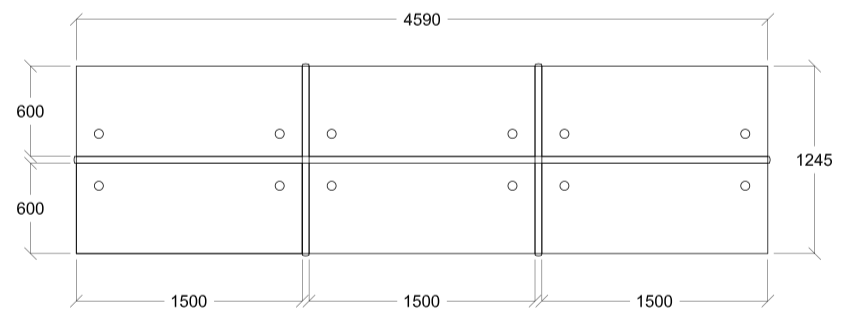



FABRIC COLOUR
Fox 803



BEGONIA CONCEPT

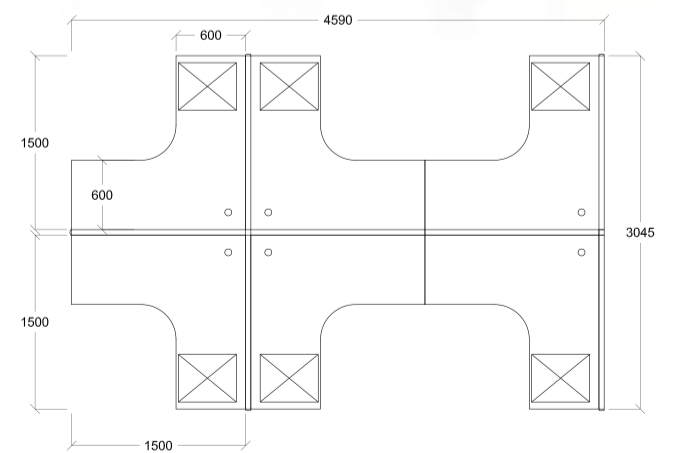

SIDE VIEW

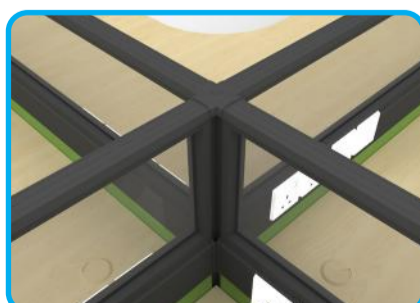

TOP VIEW

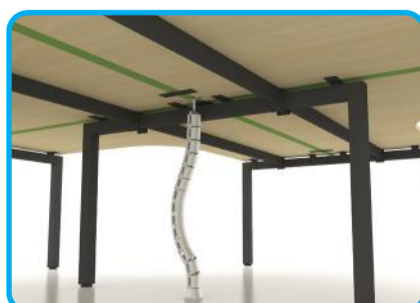

BOTTOM VIEW

BEGONIA CONCEPT

AIMS TO BE SPACIOUS AND SIMPLISTIC FOR A CURRENT TREND OF WORKSTATION SYSTEM. THE L-SHAPE TABLE SETUP WITH HALF GLASS DESKING PARTITION ALLOW EMPLOYEES TO BE MORE COOPERATIVE.



 **FABRIC COLOUR**
Fox 803

CITRUS CONCEPT

SPECIAL SIDE METAL LEG



TEE POLE



SIDE CABINET

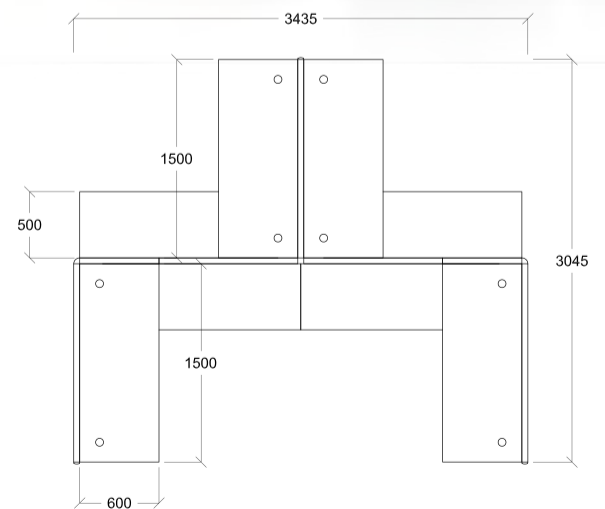

CITRUS CONCEPT
ARE COMBINATION SYSTEM YOU CAN EASILY
DESIGN AND CONFIGURE A STYLISH AND
PRODUCTIVE WORKSPACE.

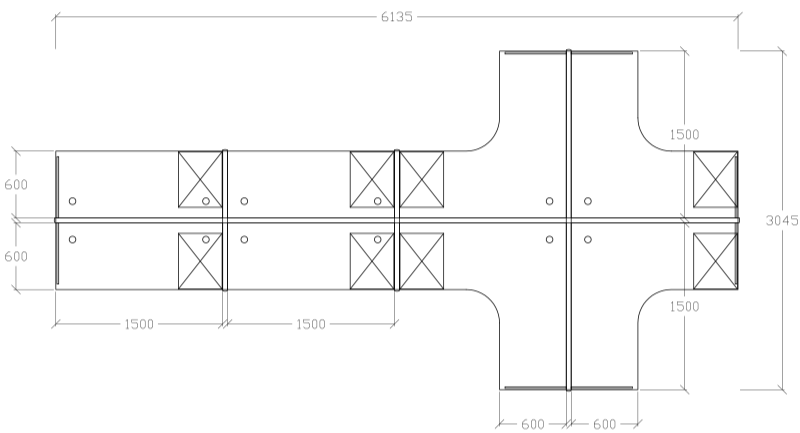

FABRIC COLOUR
Fox 803

DIODIA CONCEPT

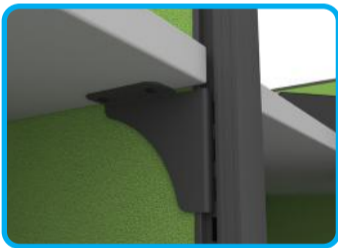

F3 BRACKET



DROP CAP



SQUARE CAP

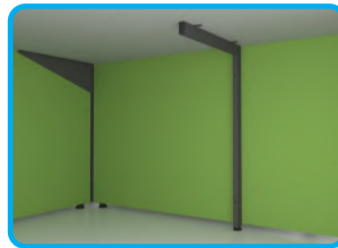

L CANTILEVER LEG



U BAR

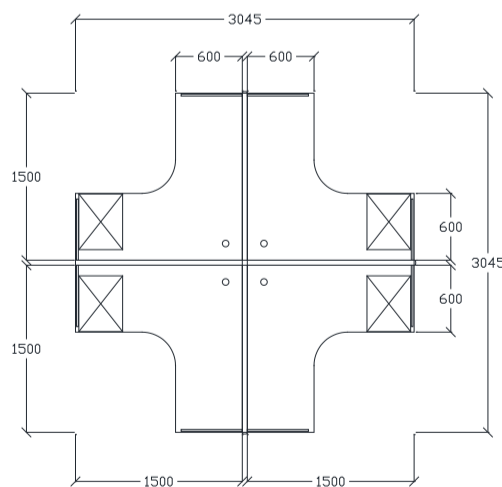
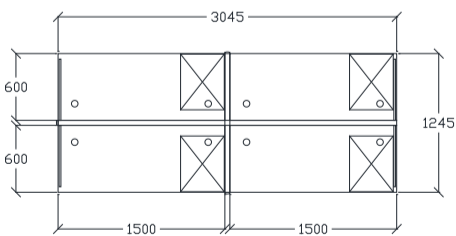

DIODIA CONCEPT

ARE ONLY 45MM THICK TO SAVE SPACE, YET THEY LOOK TOGETHER TO CREATE SOLID WORKSTATIONS THAT GIVE THE LOOK PRIVACY AND FUNCTIONALITY PERFECT FOR YOUR OFFICE.





FABRIC COLOUR



Fox 801



Fox 810

ELODIA CONCEPT

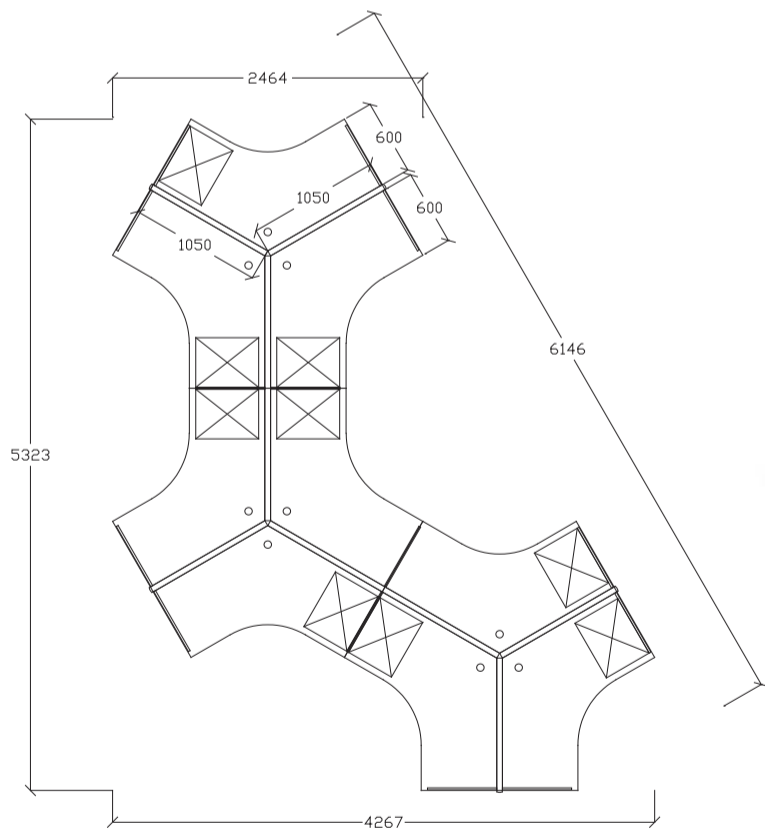

ELODIA CONCEPT

IS A 120 DEGREE WORKSTATION FOR A PLANNING TEAMWORK SOLUTION WHEN GROUP SIZE ARE VARIED AND FLEXIBLE.

CURVE PANEL LEG



END DESK PANEL

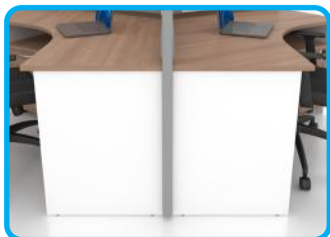

TRIANGLE CAP



F4 BRACKET



END CAP



SAMPLE (w/o SOCKET)





FABRIC COLOUR
Fox 803



ZIG-ZAG CONCEPT

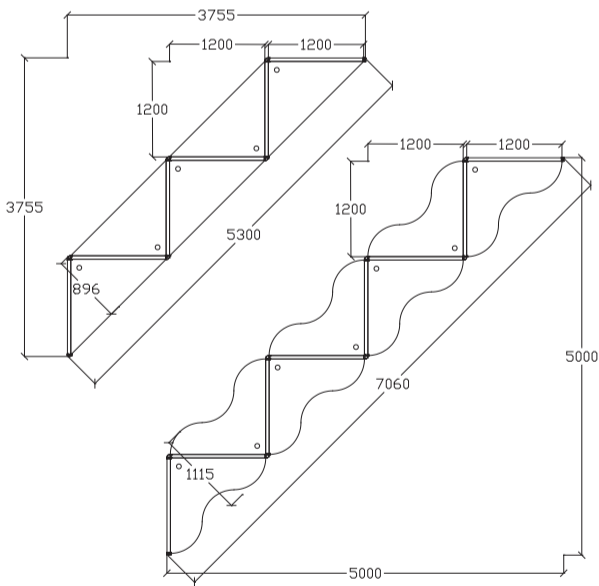

ZIG ZAG CONCEPT

IS A PERFECT SOLUTION FOR COMPANIES IN WHICH THE BASIC ROLE FULFILL TEAM CONSISTING OF A FEW PERSONS WHO NEED SPACE TO INTERACT FACTORY.





 **FABRIC COLOUR**
17-RE

HAMELIA CONCEPT

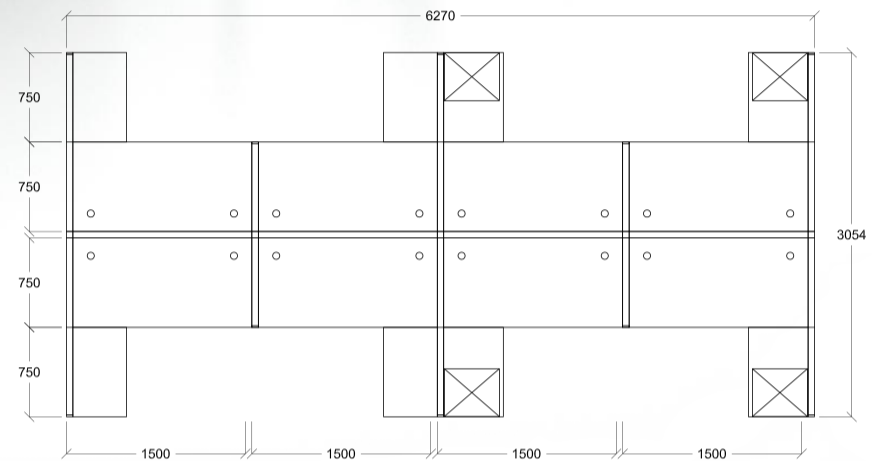

TEE SQUARE CAP



SQUARE CAP



CENTRE CAP



END CAP



DOUBLE BRACKET

SINGLE BRACKET

MOUNTING BRACKET

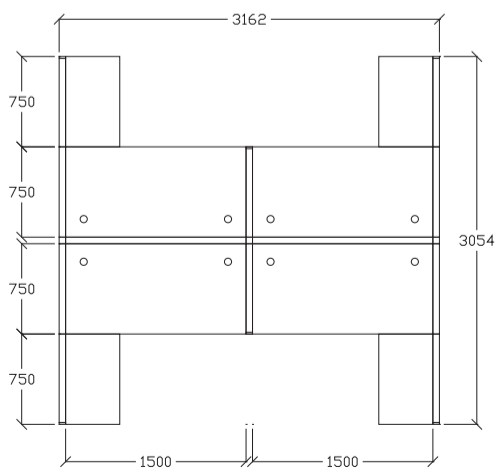

HAMELIA CONCEPT
ARE ONLY 54MM THICK TO SIMPLY WELL ORGANIZED.
EXTREMELY COST-EFFECTIVE.





FABRIC COLOUR



ITEA CONCEPT

ITEA CONCEPT

THE IMPORTANCE OF PRIVACY, PERMITS PERSONAL SPACES FOR INDIVIDUAL WORK, EVEN IN LARGE OFFICE LANDSCAPES.

END CAP



CORNER CAP



CENTRE CAP



HANGING CABINET

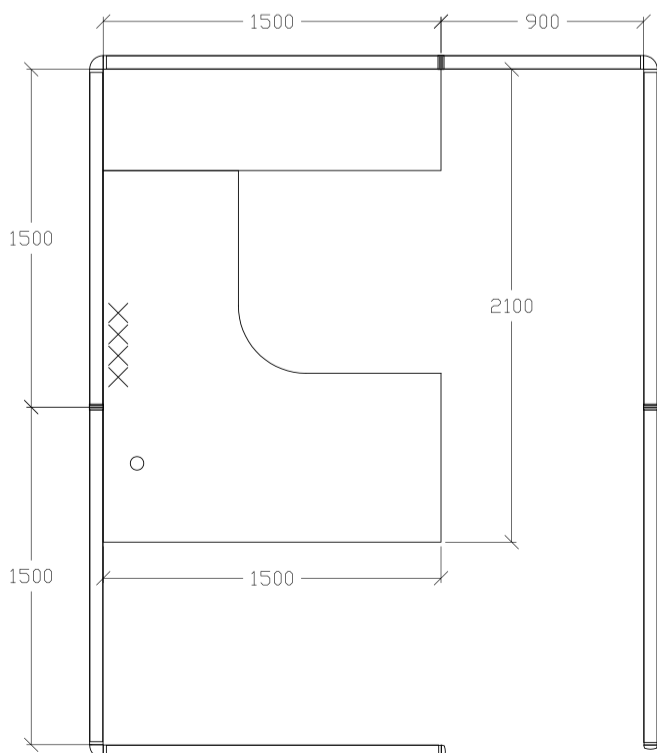



FABRIC COLOUR
43-GR

ORONTIUM CONCEPT

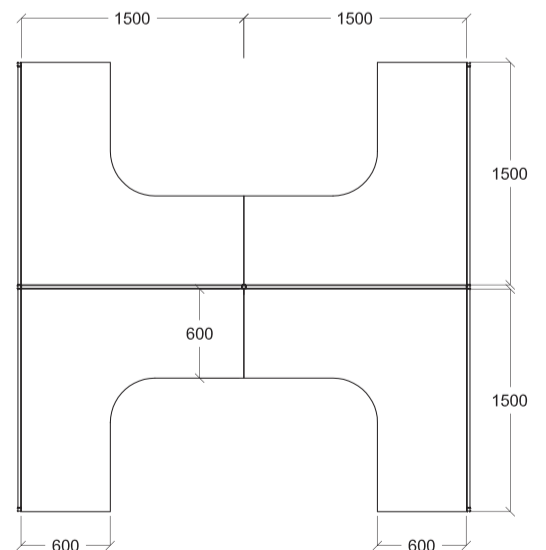
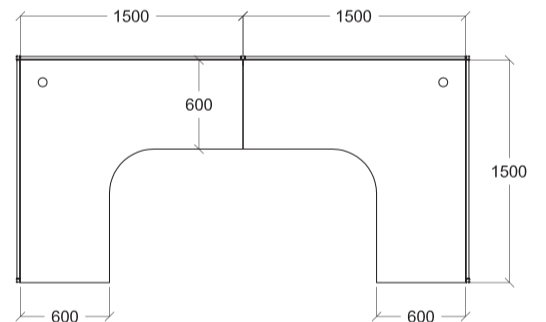

ORONTIUM CONCEPT

ARE ONLY 20MM THICKS PANELS CREATES THE FOUNDATION FOR YOUR WORK ENVIRONMENT. IT GIVES YOU THE FLEXIBILITY TO CREATE UNIQUE WORKSPACES.



HORIZONTAL WIRE TRUNKING with FLIPPER BOX



HORIZONTAL WIRE TRUNKING (w/o SOCKET)



REAR VIEW



DB 20



FLIPPER BOX (Closed View)

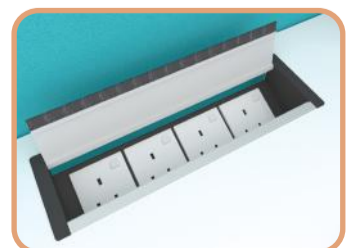

FLIPPER BOX (Open View)



FABRIC COLOUR
Fox 811

OTTELIA CONCEPT

OTTELIA CONCEPT
CREATES OPEN, SPACE EFFICIENT WORKSTATIONS
WHERE PEOPLE FEEL COMFORTABLE AND
CONNECTED.



20mm POLE CAP



20mm PARTITION with DB 20

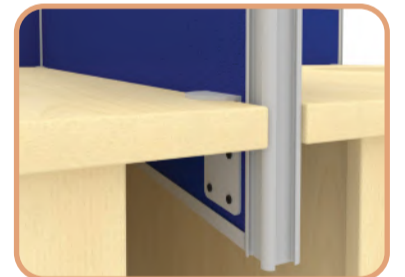

DB 20

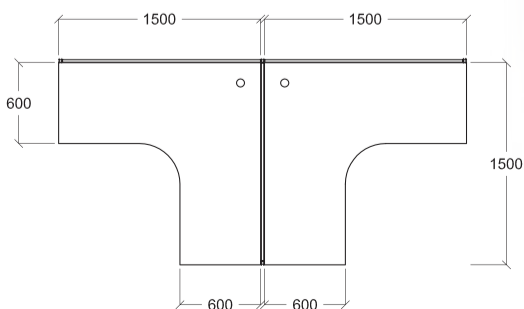
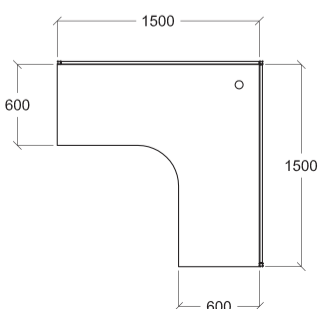
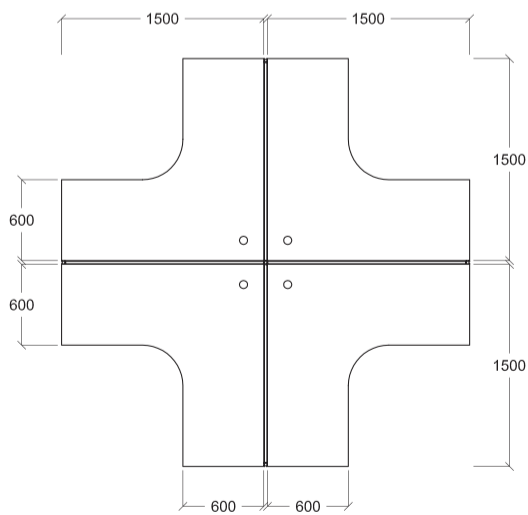



FABRIC COLOUR
53-BL

OXALIS CONCEPT

OXALIS CONCEPT

ENCOURAGES COMMUNICATION AND THE SHARING OF IDEAS. WORKSURFACES CAN BE FIXED TO ANY NUMBER OF USERS, ELIMATING BARRIERS TO TEAMWORK IN THE OPEN PLAN SYSTEM.



20mm POLE CAP

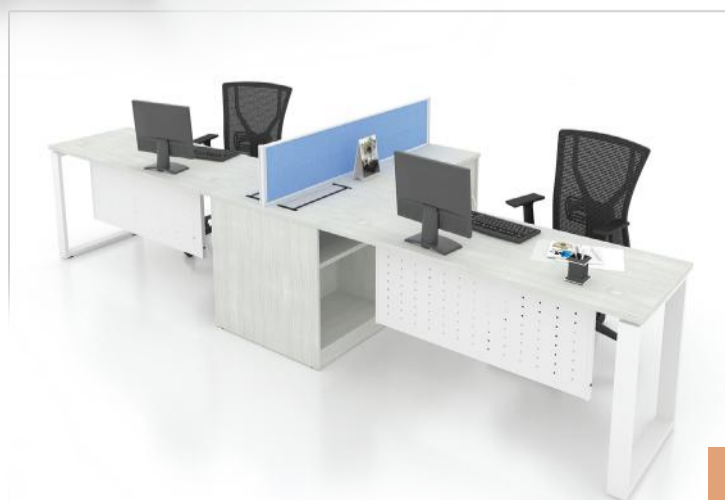
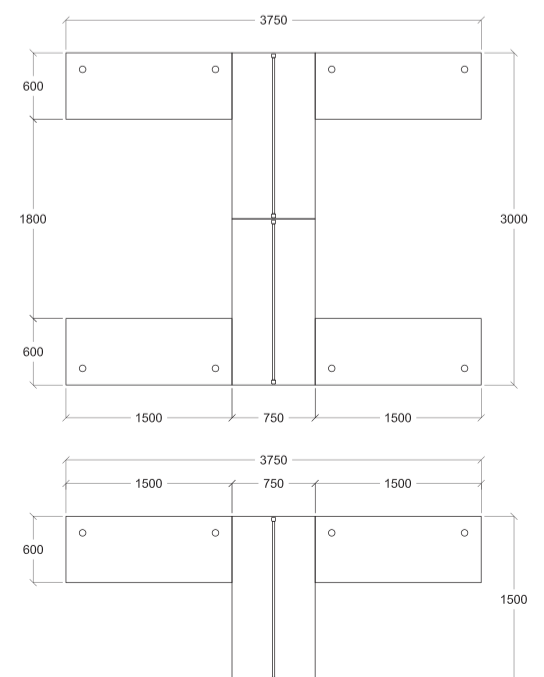

REVINA CONCEPT

FABRIC COLOUR



Fox 801 Fox 803 Fox 805



POLE LEG



MULTI SUPPORT BRACKET



TRUNKING (w/o SOCKET)



POLE CAP



U BAR & SPOON BRACKET



REVINA CONCEPT

ARE ESPECIALLY DESIGNED TO SATISFY THE COMPLEX NEEDS OF MODERN WORKING ENVIRONMENT. THE DESIGN COMES TO LIFE STARTING FROM THE STRUCTURE AND THE FORMS OF AN ELEGANT AND GRACEFUL SUPPORT.

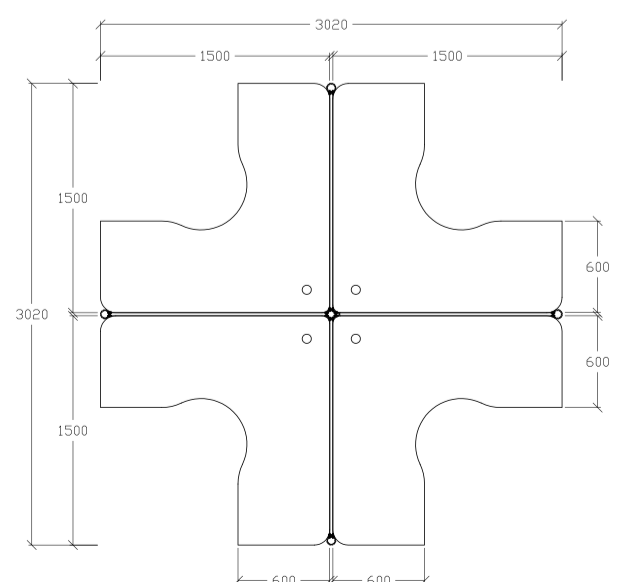

LUZIOLA CONCEPT

80MM MATRIX SYSTEM
LUZIOLA CONCEPT

33

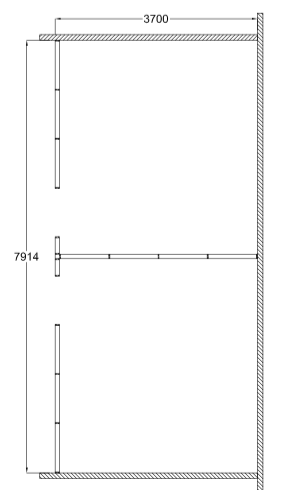
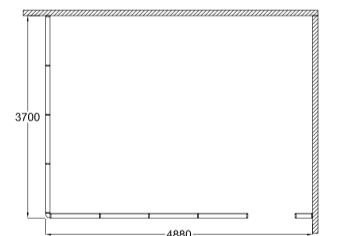
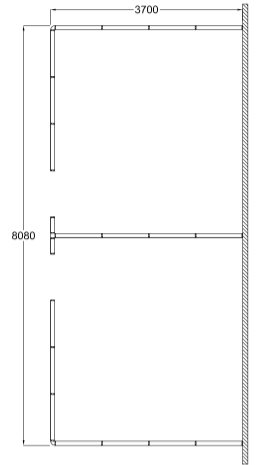
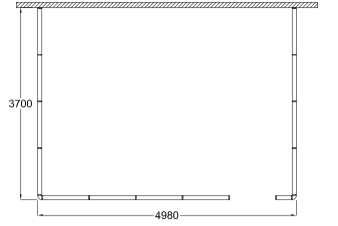

MARSILEA CONCEPT

80MM MATRIX SYSTEM
MARSILEA CONCEPT

34